

IPmux-24

TDM Pseudowire Access Gateway



TDM circuit emulation over packet-switched networks

- Comprehensive support for pseudowire/circuit emulation standards including TDMoIP, CESoPSN, SAToP, CESoETH and HDLCoPSN
- Industry-leading adaptive clock recovery mechanism suitable for cellular backhaul over packet-based networks
- Carrier-class/environmentally hardened device
- Extensive OAM and performance monitoring capabilities
- Three auto-detecting Gigabit or Fast Ethernet SFP- or UTP-based ports, and one, two or four TDM service ports



IPmux®-24 provides legacy services over packet networks. The device converts the data stream from its user E1/T1 ports into packets for transmission over the network. These packets are transmitted via the IPmux 24 Ethernet network port to the PSN. A remote pseudowire device converts the packets back to their original format.

PSEUDOWIRE FUNCTIONALITY

The ASIC-based architecture provides a robust and high performance pseudowire solution with minimal processing delay.



IPmux-24

TDM Pseudowire Access Gateway

The unit employs various pseudowire encapsulation methods, including TDMoIP, CESoPSN, SAToP, CESoETH (MEF 8) and HDLCoPSN.

Proper balance between PSN throughput and delay is achieved via configurable packet size.

A jitter buffer compensates for packet delay variation (jitter) of up to 180 msec in the network.

PSEUDOWIRE QoS/CoS

Ethernet networks – outgoing pseudowire packets are assigned a dedicated VLAN ID according to 802.1q and marked for priority using 802.1P bits.

IP networks – outgoing pseudowire packets are marked for priority using DSCP, ToS, or Diffserv bits.

MPLS networks – outgoing pseudowire packets are assigned to a specific MPLS tunnel and marked for priority using EXP bits.

PSEUDOWIRE TIMING

End-to-end synchronization between circuits is maintained by deploying advanced clock recovery mechanisms.

Clock recovery conforms to G.823 and G.824 traffic interface using G.8261-defined scenarios.

Advanced clock recovery conforms to G.823 synchronization interface using G.8261-defined scenarios and achieves 16 ppb clock accuracy.

The system clock ensures a single clock source for all TDM links. The system clock uses master and fallback timing sources for clock redundancy. IPmux-24 also provides system clock input and output via an optional external clock port.

TDM INTERFACE

One, two or four E1 or T1 ports provide connectivity to any standard E1 or T1 device.

The E1 and T1 interfaces feature:

- Integral LTU/CSU for long haul applications
- G.703 and G.704 framing modes
- CAS and CRC-4 bit generation (E1)
- D4/SF and ESF framing (T1)
- Robbed bit (T1).

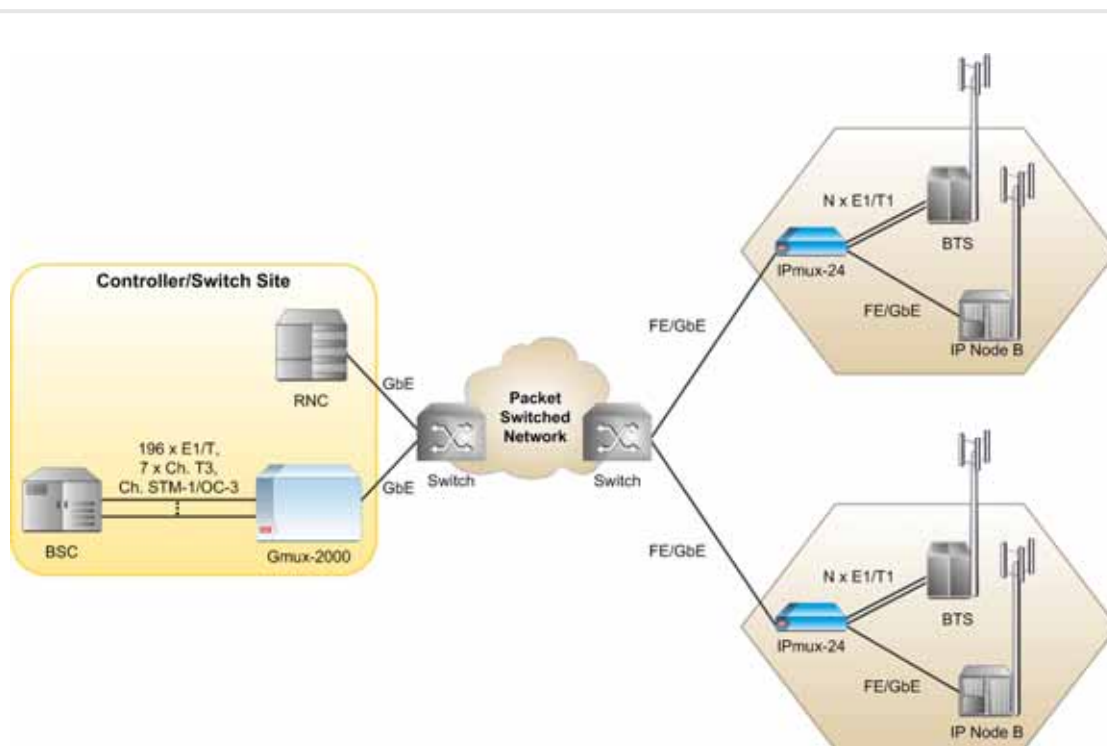

Figure 1. 2G/3G Cellular Backhaul

ETHERNET INTERFACE

The following Ethernet ports are available:

- One network port
- One network/user port
- One user port.

The Ethernet ports accept a wide range of Gigabit and Fast Ethernet SFP-based fiber optic and electric, as well as built-in UTP interfaces.

The unit can also be ordered with Fast Ethernet interfaces only (IPmux-24/FE).

ETHERNET CAPABILITIES

IPmux-24 features an internal bridge, operating in VLAN-aware and VLAN-unaware modes.

VLAN stacking is used for traffic separation between different users or services, by defining a service provider VLAN ID per customer or service. When VLAN stacking is used, a service provider VLAN tag is added to the user traffic and removed from network traffic. Both service provider VLAN ID and service provider VLAN priority can be defined.

IPmux-24 provides four priority queues for each port or pseudowire traffic flow. User traffic can be prioritized according to VLAN priority, DSCP, IP Precedence or per port.

Ingress and egress rate can be limited per user and network port. Rate limitation is configured per packet type.

ETHERNET RING TOPOLOGIES

A G.8032 Layer-2 Ethernet ring is used by IPmux-24 for traffic protection. This technology builds a logical ring, defined as a set of IEEE 802.1-compliant bridges, and protects against link and node failures. To achieve this, every node in the ring has two bridge ports connected to adjacent nodes. The ring itself is constructed independently of the transport technology used at the server layer. Failures in the ring are detected by using Ethernet OAM (Y.1731) continuity check (CC) messages between adjacent nodes.

In addition, the unit employs Resilient Ethernet Ring technology to construct a self-healing Ethernet fiber ring topology (ring resiliency is similar to that of SDH/SONET networks). In case of link failure on any segment of the ring, the pseudowire traffic is rerouted within 50 ms. A single ring supports up to 16 nodes.

ETHERNET LINK PROTECTION

The unit performs link aggregation (LAG) based on 802.3ad requirements.

Dual homing technology (1:1) allows IPmux-24 to be connected to two different upstream devices.

PSEUDOWIRE TRAFFIC PROTECTION

Pseudowire traffic can be backed up at the pseudowire connection level. This allows setting a different path for the primary and secondary PW bundles. Both bundles can be routed to the same or different destinations and operate in the 1+1 and 1:1 modes.

In 1:1 redundancy with two remote devices the PW bundles in the remote units operate in "mate" mode. In this mode each device monitors traffic on a mate bundle and transfers data only when the other bundle is inactive.

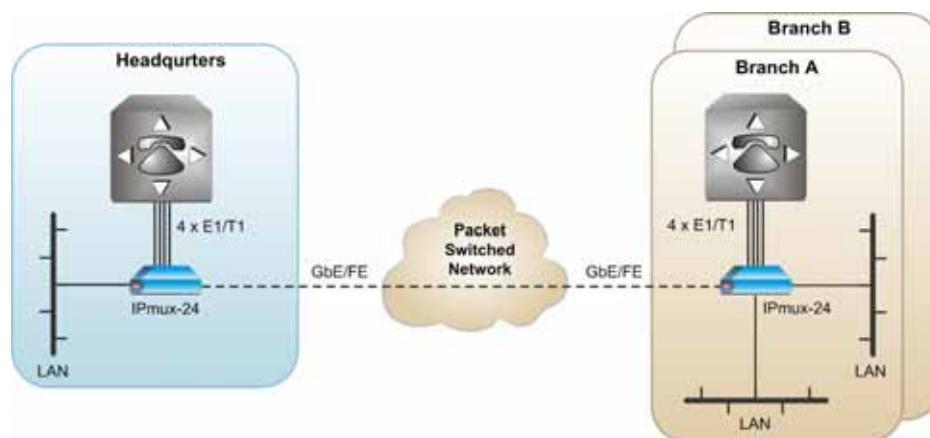

Figure 2. Private or Leased Line over PSN

Preserves investment
in legacy equipment in
migration to PSN

ETHERNET SERVICE OAM (802.1ag)

The unit uses the end-to-end Ethernet-layer OAM protocol for proactive connectivity monitoring, fault verification, and fault isolation, according to the IEEE 802.1ag and ITU-T Y.1731 requirements.

LINK OAM (IEEE 802.3ah)

Link-layer OAM according to IEEE 802.3ah is used for fault indication and loopback activation response.

MANAGEMENT

IPmux-24 can be configured and monitored locally via an ASCII terminal, or remotely via Telnet/SSH, Web browser or RADview.

Management traffic can run over a dedicated VLAN.

The RADview Service Center and Element Manager packages control and monitor pseudowire devices and circuits. The Service Center's intuitive GUI, "point and click" functionality and easy-to-follow wizards increase the efficiency and accuracy of the service provisioning process.

IPmux-24 performs RADIUS client authentication. Using SSH and SSL encryption protocols allows secure communication over potentially insecure IP-based networks.

The Syslog protocol is used by IPmux-24 to generate and transport event notification messages over IP networks to the central Syslog server. The Syslog operation is compliant with the RFC 3164 requirements.

SNMPv3 support introduces a user-based security model, enhances authentication and encryption techniques, and ensures management traffic security.

Each management and service host has a separate MAC address. As the unit provides one default gateway, the user can also specify static routes to enhance the IP routing capabilities of the management and pseudowire traffic.

Software is downloaded via the local terminal, using XMODEM, or remotely, using TFTP. After downloading a new software version, IPmux-24 automatically saves the previous version in non-volatile memory for backup purposes. Similarly, copies of the configuration file may be downloaded and uploaded to a remote workstation for backup and restore purposes.

OAM AND DIAGNOSTICS

The following RFC-2495 E1/T1 physical layer performance statistics are available: LOS, LOF, LCV, RAI, AIS, FEBE, BES, DM, ES, SES, UAS and LOMF.

IPmux-24 performs an internal built-in test (BIT) after power-up. The results of the test are visible via the local terminal.

LAN and IP layer network condition statistics, such as packet loss and packet delay variation (jitter) are monitored and stored by the device.

Fault isolation, statistics and event logging are available.

Fault propagation initiates service port alarms, e.g. E1/T1 LOS, to reflect network fault conditions. Alarms detected at service ports are propagated to the remote pseudowire device via the packet network.

Diagnostic loopbacks can be activated inband.

Ethernet and IP-layer network condition statistics, such as packet sequence errors (loss or misorder) and packet delay variation (jitter), are monitored and stored by the device.

RAD's TDM PW OAM mechanism verifies connectivity, measures round trip delay and prevents pseudowire configuration mismatch.

The carrier-class version of IPmux-24 includes an alarm relay mechanism. The minor and major alarms are forwarded to a remote alarm device via dedicated pins of the external clock RJ-45 connector.

SIMPLE NETWORK TIME PROTOCOL

IPmux-24 employs Simple Network Time Protocol (SNTP) for propagating and receiving time information on a network, according to SNTPv4 (RFC 4330) requirements. SNTP is used to configure data and time by learning the information from a single or multiple NTP servers. The clock can be configured to a local time by defining UTC and DST offsets.

ENVIRONMENT

IPmux-24/H is an environmentally hardened version intended for street-cabinet and cellular-tower installations.

Notes: The /H version requires temperature hardened SFP transceivers.

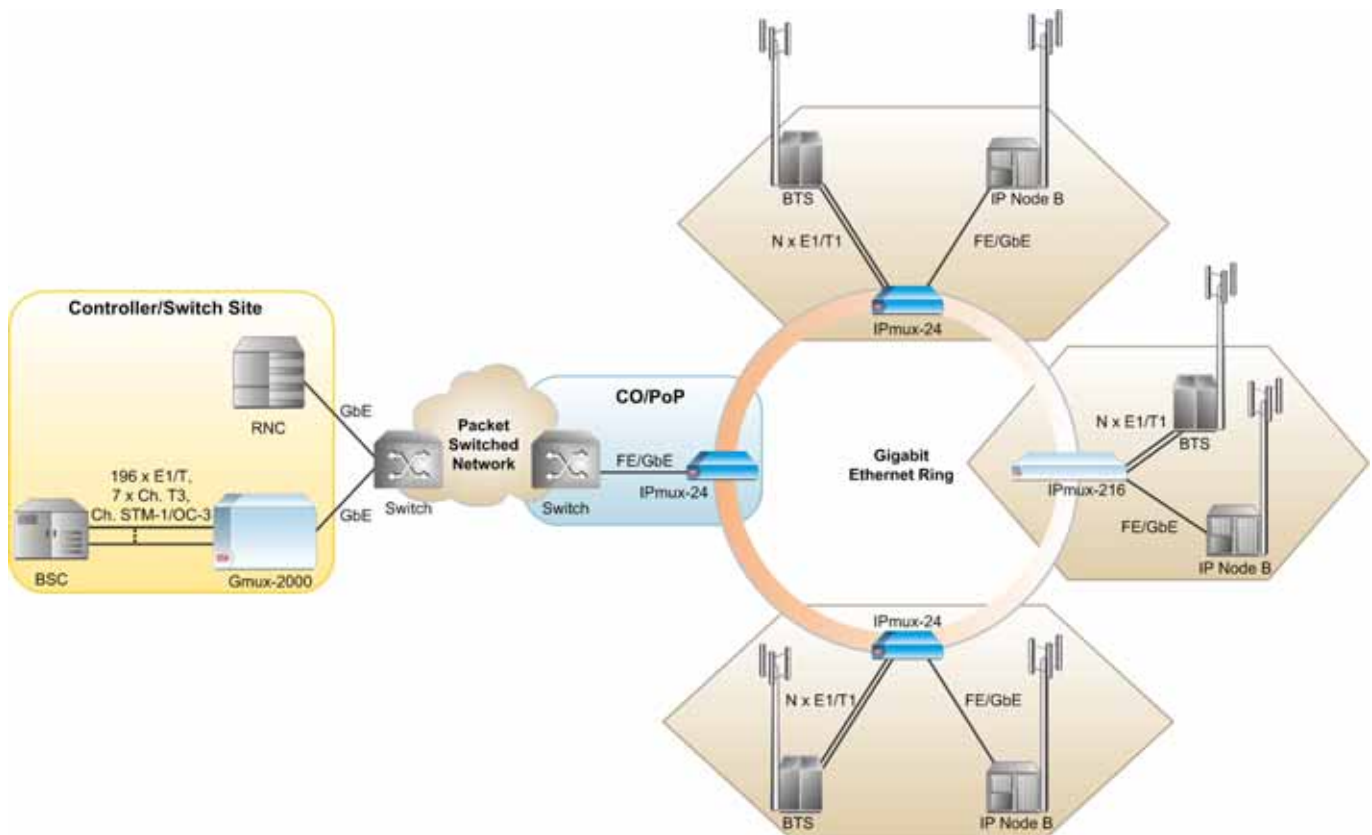

Figure 3. Delivering Ethernet and TDM Services over Fiber Ring in the First Mile

Lowers Opex of TDM service by utilizing packet infrastructure

Specifications

E1 INTERFACE

Number of Ports

1, 2 or 4

Compliance

ITU-T Rec. G.703, G.704, G.706, G.732, G.823

Data Rate

2.048 Mbps

Line Code

HDB3

Framing

Unframed, framed, multiframe; with or without CRC-4

Signaling

CAS, CCS (transparent)

Line Impedance

120Ω, balanced

75Ω, unbalanced

Signal Levels

Receive:

0 to -36 dB with LTU (long haul)

0 to -10 dB without LTU (short haul)

Transmit balanced: $\pm 3V \pm 10\%$

Transmit unbalanced: $\pm 2.37V \pm 10\%$

Jitter and Wander Performance

Per AT&T TR-62411, ITU-T G.824 (for internal, loopback and external clock modes)

Connector

Balanced: RJ-45

Unbalanced: BNC (RJ-45 to BNC adapter cable is supplied)

T1 INTERFACE

Number of Ports

1, 2 or 4

Compliance

ANSI T1.403, ITU-T Rec. G.703, G.704, G.824

Data Rate

1.544 Mbps

Line Code

B8ZS, B7ZS, AMI

Framing

Unframed, SF, ESF

Signaling

CAS (bit robbing), CCS (transparent)

Line Impedance

100Ω, balanced

Signal Levels

Receive: 0 to -36 dB

Transmit pulse amplitude:

$\pm 3V \pm 20\%$; 0 dB, -7.5 dB, 15 dB (CSU), user-selectable

$\pm 2.7V \pm 10\%$, 0 to 655 feet, (DSU), user-selectable

Jitter and Wander Performance

Per AT&T TR-62411, ITU-T G.824 (for internal, loopback and external clock modes)

Connector

RJ-45

ETHERNET INTERFACE

Compliance

IEEE 802.3, 802.3u, 802.1p&Q

Number of Ports

3, network or user

Port Combinations

3 fiber optic SFPs

2 fiber optic SFPs + 1 UTP

1 fiber optic SFP + 2 UTPs

3 UTPs (Fast Ethernet unit only)

Type

SFP-based:

Gigabit Ethernet – 1000BaseSx,
1000BaseLX10, 1000BaseBx10

Fast Ethernet – 100BaseFx,
100BaseLX10, 100BaseBx10

10/100/1000BaseT with SGMII

Built-in:

10/100BaseT

Fast and Gigabit Ethernet SFPs

For full details, see the SFP Transceivers data sheet at www.rad.com

Note: It is strongly recommended to order this device with **original RAD SFPs installed**. This will ensure that prior to shipping, RAD has performed comprehensive functional quality tests on the entire assembled unit, including the SFP devices. RAD cannot guarantee full compliance to product specifications for units using non-RAD SFPs. For detailed specifications of the SFP transceivers, see the SFP Transceivers data sheet.

Connector

LC

PSEUDOWIRE

Compliance

IETF: RFC 4553 (SAToP), RFC 5087
(TDMoIP), RFC 5086 (CESoPSN),
RFC 4618 (excluding clause 5.3 – PPP)

ITU-T: Y.1413

MFA: IA 4.1, IA 8.0.0

MEF: 8, 9, 14 (EPL-certified)

Number of PW Connections

64

Jitter Buffer Size

0.5–180 msec (unframed) with 0.1 msec granularity

2.5–180 msec (framed) with 0.5 msec granularity

IPmux-24/A Adaptive Clock

Frequency accuracy: ± 16 ppb and G.823 synchronization interface requirements (clause 6), when locked to a PRC (stratum 1) or SSU (stratum 2) clock

Frequency accuracy in holdover: ± 16 ppb ± 1 ppb of aging per day

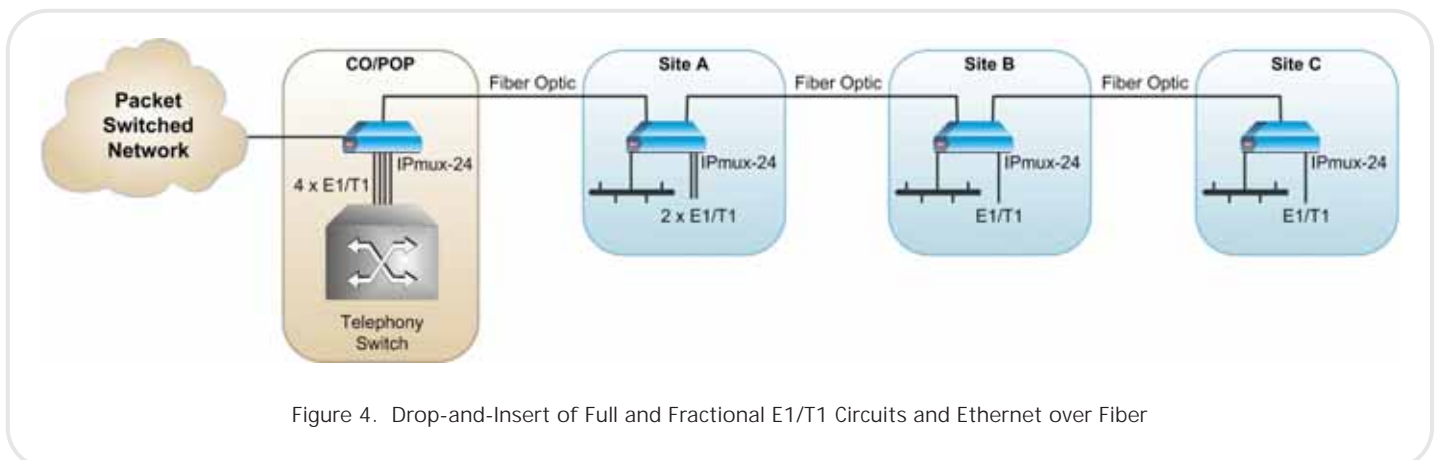

Figure 4. Drop-and-Insert of Full and Fractional E1/T1 Circuits and Ethernet over Fiber

IPmux-24

TDM Pseudowire Access Gateway

GENERAL

Timing

Internal

Loopback

Adaptive

External input or output via optional dedicated RJ-45 port: E1/T1 or 2048/1544 kHz squarewave (RS-422 electrical levels)

Management

SNMPv1, SNMPv3

Telnet

RADview Service Center TDMoIP (ordered separately)

ASCII terminal via V.24 (RS-232) DCE port

Diagnostics

E1/T1 local loopback

E1/T1 remote loopback

Facility Type 1 (FAC1) inband loopback

CSU loopback as per Telecordia GR-54

Statistics

E1/T1 (per G.826 and RFC 2495)

Ethernet (per RFC 2819)

Jitter buffer indication (overflow, underflow, sequence error)

Alarm Relay

Via pin 6, pin 7 and pin 8 of the EXT. CLK connector (RJ-45), optional

Indicators

PWR (green) – Power status

TST/ALM (red/yellow) – Test/alarm status

E1/T1 SYNC (green/red) – E1/T1 synchronization status

LINK/ACT (green) – Ethernet link/activity status

EXT. CLK (red/green) – External clock status

Power

AC/DC: 100–240 VAC, 50/60 Hz or 48/60 VDC nominal (40 to 72 VDC)

DC: 24/48/60 VDC nominal (18 to 72 VDC)

Power Consumption

12W max

Physical

Height: 47 mm (1.8 in)

Width: 215 mm (8.4 in)

Depth: 147 mm (5.8 in)

Weight: 0.7 kg (1.5 lb)

Environment

Temperature:







IPmux-24: 0 to 50°C (32 to 122°F)

IPmux-24/H: -30 to 65°C
(-22 to 149°F)

Humidity: Up to 90%, non-condensing

Carrier-grade voice
quality without
compression, or
silence suppression

Table 1. IPmux Family Product Comparison

Feature	IPmux-2L (Ver. 1.0)	IPmux-4L (Ver. 1.0)	IPmux-4L (GbE) (Ver. 2.0)	IPmux-16L (Ver. 1.0)	IPmux-24 (Ver. 3.5)	IPmux-216 (Ver. 3.5)
						
TDM service ports	1, 2 × E1	2, 4 × E1	4 × E1	8, 16 × E1	1, 2, 4 × E1/T1	8, 16 × E1/T1
Ethernet network ports	1 × FE	1 × FE	1 × GbE network, 2 × GbE network/user	3 × GbE network/user 3 × FE network/user	1 × GbE/FE network, 1 × GbE/FE network/user	1 × GbE/FE network 1 × GbE/FE network/user
Ethernet subscriber ports	1 or 2 × FE	1 or 2 × FE	4 × FE		1 × GbE/FE	1 × GbE/FE
Number of PWs	63	64	64	256	64	256
Multi-pseudowire	✓	✓	✓	✓	✓	✓
Advanced clock recovery	–	✓	✓	✓	✓	✓
Redundant power supply	–	–	–	–	–	✓
External clock port	–	–	–	✓	Optional	✓
Serial data port	Optional	–	–	–	–	–
SSH, SSL, RADIUS	–	–	–	–	✓	✓
Network management system	RV-EMS	RV-EMS	RV-EMS	RV-EMS	RV-SC/TDMoIP, RV-EMS (basic shelf view)	RV-SC/TDMoIP, RV-EMS (basic shelf view)

IPmux-24

TDM Pseudowire Access Gateway

Ordering

STANDARD CONFIGURATIONS

IPMUX-24/1E1/N/N/N
IPMUX-24/1E1CX/N/N/N
IPMUX-24/1T1/N/N/UTP
IPMUX-24/4T1/N/N/UTP
IPMUX-24/FE/1E1/UTP/UTP/UTP
IPMUX-24/FE/1E1CX/UTP/UTP/UTP
IPMUX-24/FE/1T1/UTP/UTP/UTP
IPMUX-24/FE/2E1/UTP/UTP/UTP
IPMUX-24/FE/2E1CX/UTP/UTP/UTP
IPMUX-24/FE/2T1/UTP/UTP/UTP
IPMUX-24/FE/4E1/UTP/UTP/UTP
IPMUX-24/FE/4E1CX/UTP/UTP/UTP
IPMUX-24/FE/4T1/UTP/UTP/UTP
IPMUX-24/FE/A/4T1/N/N/UTP

SPECIAL CONFIGURATIONS

IPMUX-24/+!/?/-/CC/\$/+1/+2/+3

Legend

+ Ethernet interface (Default=FE and GbE capabilities)

FE Fast Ethernet interface only

Note: FE option is mandatory when UTP/UTP/UTP port combination is required.

! Power supply (Default=AC/DC):

WRDC Wide range DC power supply for environmentally hardened device

? Enclosure (Default=regular enclosure):

H Environmentally hardened enclosure

~ Clock recovery (Default=standard clock recovery):

A Advanced clock recovery mechanism (per TDM port)

CC Package (Default=no carrier-class package)

C Carrier-class package (external clock and alarm relay)

\$ TDM interface:

1E1 Single balanced E1 interface

1E1CX Single unbalanced E1 interface

1T1 Single balanced T1 interface

2E1 2 balanced E1 interfaces

2E1CX 2 unbalanced E1 interfaces

2T1 2 balanced T1 interfaces

4E1 4 balanced E1 interfaces

4E1CX 4 unbalanced E1 interfaces

4T1 4 balanced T1 interfaces

Note: Unbalanced E1 interfaces are provided via RJ-45 to BNC adapter cables supplied with the product.

+1 Network interface:

N SFP-ready slot

1 Fast Ethernet/STM-1, 1310 nm, multimode, LED, 2 km (1.2 mi)

2 Fast Ethernet/STM-1, 1310 nm, single mode, laser, 15 km (9.3 mi)

2H Fast Ethernet/STM-1, industrially hardened, 1310 nm, single mode, laser, 15 km (9.3 mi)

3 Fast Ethernet/STM-1, 1310 nm, single mode, laser, 40 km (24.8 mi)

3H Fast Ethernet/STM-1, industrially hardened, 1310 nm, single mode, laser, 40 km (24.8 mi)

4 Fast Ethernet/STM-1, 1550 nm, single mode, laser, 80 km (49.7 mi)

10A Fast Ethernet/STM-1, Tx – 1310 nm, Rx – 1550 nm, single mode (single fiber), laser (WDM), 20 km (12.4 mi)

10B Fast Ethernet/STM-1, Tx – 1550 nm, Rx – 1310 nm, single mode (single fiber), laser (WDM), 20 km (12.4 mi)

18A Fast Ethernet/STM-1, Tx – 1310 nm, Rx – 1550 nm, 9/25 single mode (single fiber), laser (WDM), 40 km (24.8 mi)

18B Fast Ethernet/STM-1, Tx – 1550 nm, Rx – 1310 nm, 9/25 single mode (single fiber), laser (WDM), 40 km (24.8 mi)

19A Fast Ethernet/STM-1, Tx – 1490 nm, Rx – 1570 nm, 9/25 single mode (single fiber), laser (WDM), 80 km (49.7 mi)

19B Fast Ethernet/STM-1, Tx – 1570 nm, Rx – 1490 nm, 9/25 single mode (single fiber), laser (WDM), 80 km (49.7 mi)

- 5 Gigabit Ethernet, 850 nm, multimode, VCSEL, 0.55 km (0.3 mi)
- 5H Gigabit Ethernet, industrially hardened, 850 nm, multimode, VCSEL, 0.55 km (0.3 mi)
- 6 Gigabit Ethernet, 1310 nm, single mode, laser, 10.0 km (6.2 mi)
- 6H Gigabit Ethernet, industrially hardened, 1310 nm, single mode, laser, 10.0 km (6.2 mi)
- 7 Gigabit Ethernet, 1550 nm, single mode, laser, 80.0 km (49.7 mi)
- 8 Gigabit Ethernet, 1310 nm, single mode, laser, 40.0 km (24.8 mi)
- 8H Gigabit Ethernet, industrially hardened, 1310 nm, single mode, laser, 40.0 km (24.8 mi)
- 17A Gigabit Ethernet, Tx -1310 nm, Rx -1490 nm, single mode (single fiber), laser (WDM), 10.0 km (6.2 mi)
- 17B Gigabit Ethernet, Tx -1490 nm, Rx -1310 nm, single mode (single fiber), laser (WDM), 10.0 km (6.2 mi)
- 20 Gigabit Ethernet, 1550 nm, single mode, laser, 120.0 km (74.5 mi)

- 22A Gigabit Ethernet, Tx -1490 nm, Rx -1570 nm, single mode (single fiber), laser (WDM), 80.0 km (49.7 mi)
- 22B Gigabit Ethernet, Tx -1570 nm, Rx -1490 nm, single mode (single fiber), laser (WDM), 80.0 km (49.7 mi)
- 9F Fast Ethernet, RJ-45 connector, 100m (238 ft)
- 9G GbE interface, RJ-45 connector, 100m (238 ft)
- 30 10/100/1000BaseT (with SGMII), RJ-45 connector, 100m (238 ft)
- UTP Built-in 10/100BaseT

+2 Network/user interface:

See the network interface ordering options above

Note: It is strongly recommended to order this device with **original RAD SFPs installed**. This will ensure that prior to shipping, RAD has performed comprehensive functional quality tests on the entire assembled unit, including the SFP devices. RAD cannot guarantee full compliance to product specifications for units using non-RAD SFPs. For detailed specifications of the SFP transceivers, refer to the SFP Transceivers data sheet.

+3 User interface:

See the network/user interface ordering options above

Network	Network/User	User
N	N	N
N	N	UTP
N	UTP	UTP
UTP	UTP	UTP
UTP	UTP	N
UTP	N	N

Note: The N (SFP-ready slot) option in Table 2 can be replaced with any SFP transceiver supported by IPmux-24.

IPmux-24

TDM Pseudowire Access Gateway

SUPPLIED ACCESSORIES

Power cord

AC/DC adapter plug

CBL-RJ45/2BNC/E1/X

RJ-45 to BNC adapter cable (if an unbalanced E1 interface is ordered)

OPTIONAL ACCESSORIES

RM-35/@

Hardware kit for mounting one or two IPmux-24 units into a 19-inch rack

Legend

@ Rack mounting kit (Default=both kits):

- P1** Kit for mounting one unit
- P2** Kit for mounting two units

CBL-DB9F-DB9M-STR

Control port cable

International Headquarters
 24 Raoul Wallenberg Street
 Tel Aviv 69719, Israel
 Tel. 972-3-6458181
 Fax 972-3-6498250, 6474436
 E-mail market@rad.com

North America Headquarters
 900 Corporate Drive
 Mahwah, NJ 07430, USA
 Tel. 201-5291100
 Toll free 1-800-4447234
 Fax 201-5295777
 E-mail market@rad.com

www.rad.com

Order this publication by Catalog No. 803782



data communications

The Access Company